



Benner-Nawman, Inc.

3450 Sabin Brown Road • Wickenburg, AZ 85390

(800) 992-3833 • (928) 684-2813 • www.bnproducts.com

Specification Sheet

Part #
BN14326W-SM

***This Cabinet Measures:
14" Wide x 32" Tall x 6" Deep***

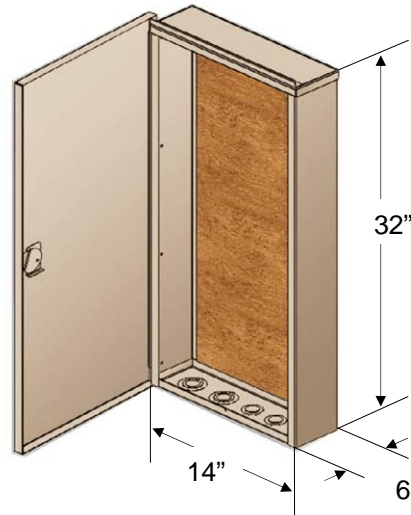

Features & Info:

- Includes 1/2" plywood backboard & 4-position, #4-14 wire ground bar mounted inside
- Includes 2 knockouts 1" - 2" (for 3/4" - 1 1/4" conduit) & 3 knockouts 1" - 1 1/2" (for 3/4" - 1 1/4" conduit) See Chart Below
- Made of 16-gauge zinc-coated steel w/ a desert tan powder coat finish
- Reinforced hinged lid with 7/16" recessed hex latch
- "COMMUNICATIONS" embossed on the cover
- UL-Listed (UL1863), designed to NEMA 3R
- Box weight: 37 lbs.

Knockout Pattern

